

Displacement Ventilation Diffusers

Models SD1, SD2, SD3, and SD6

Features

- 4 Standard Models
- Corner
- Circular
- Semi – Circular
- Rectangular
- Steel and Aluminium Construction



Air Diffusion

Grilles Diffusers Louvres Chilled Beams

Ruskin Air Management Limited
www.ruskinuk.co.uk

Contents

	Page
Introduction	Page 2
Model Types	Page 2 and 3
Accessories	Page 4
Application and Selection Guide	Page 5 - 9
Dimension Information	Page 10 - 11
Ordering Information	Page 12

Introduction

Introduction

Displacement ventilation systems, as the name implies, rely on a displacement process of the supply air into the occupied zone. Typically the supply air is introduced at low level and at a low velocity to displace the room air and provide layers of cool fresh air in the occupied zone while the extract removes stale air at high level. Supply air temperature differentials are normally low and offer the opportunity to take advantage of using fresh air based on “free cooling” for much of the year.

The SD range of displacement diffusers are ideally suited for use in areas with high heat loads requiring air volumes up to 2800 l/s. By using the effects of convection to lift the supply air from heat sources, whilst at the same time removing any pollutants, the air is then extracted at high level, thus creating an even temperature, draught free, clean environment.

Four conventional shapes are available, Corner, Semi-Circular, Circular and Rectangular. More unconventional Trapezoidal and Hexagonal shapes are also available, on request.

Model SD-1 Corner

Model SD-2 Semi Circular

Model SD-3 Circular

Model SD-6 Rectangular

The diffusers are constructed from steel and aluminium with the active area constructed from 5.5mm circular perforated aluminium giving a 37% free area or 10mm square perforated aluminium giving a 69% free area, the remainder of the unit is from sheet steel. A complete range of accessories is available including, spigot dampers, peripheral or bag filters, dividing rings and air direction vanes.

The standard colour is White RAL9010 30% gloss although other colours and finishes are available on special request.

Displacement Ventilation Diffusers

Model Types

All model types are available in 6 standard nominal sizes;

400, 600, 800, 1000, 1500 and 2000

and 6 standard heights;

750, 1000, 1250, 1500, 2000 and 2500.

Each model type is available in 6 different versions,

Supplied with 37% free area 5.5mm round mesh facia as standard

F1 – Plain without filters,

F2 – Fitted with a cone shaped bag filter,

F5 – With dividing rings.

Supplied with 69% free area 10mm square mesh facia as standard

F3 – Fitted with a peripheral filter media,

F4 – Fitted with both a cone bag filter and peripheral filter media,

F6 – Fitted with peripheral filter media and dividing rings.

Model SD-1 Corner



Model SD-2 Semi Circular



Model SD-3 Circular



Model SD-6 Rectangular



Model Components

1. Perforated Face
2. Bottom Section
3. Circular Inlet Spigot
4. Flap Damper (when requested)
5. Cone Shaped Bag Filter
6. Dividing Rings
7. Peripheral Filter Media
8. Top Section

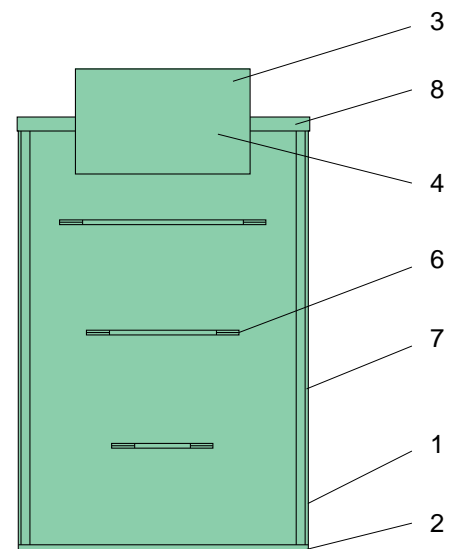
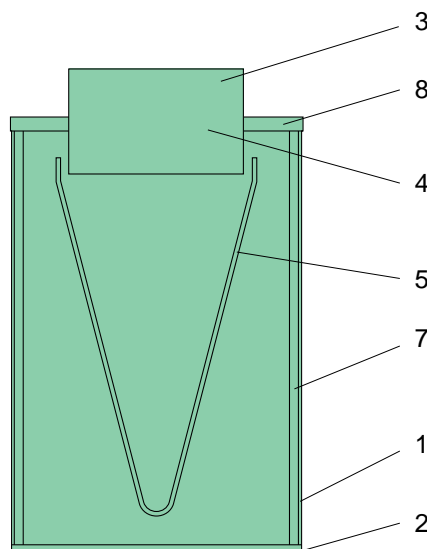

Accessories

Air Direction Adjustment Vanes - Model SD-3 Only (Type R1)

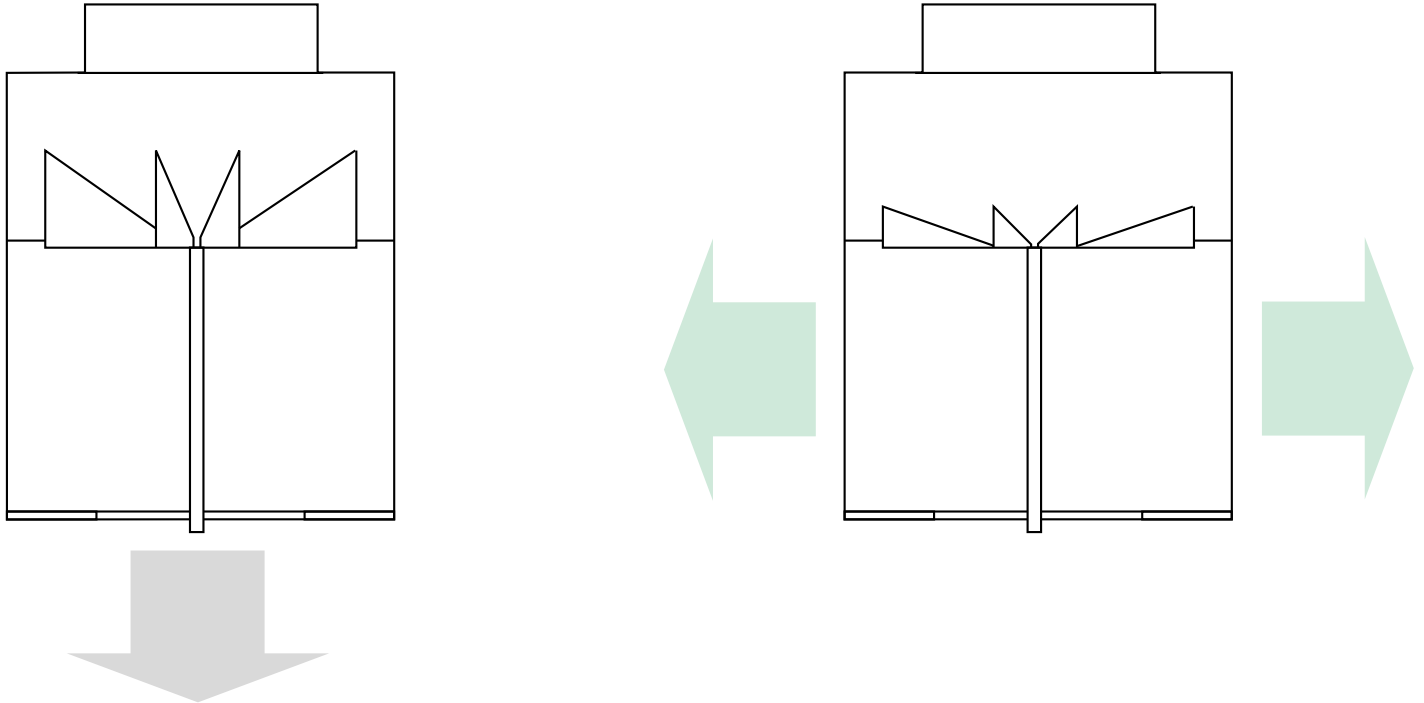

Air Direction Adjustment Vanes and Control Damper - Model SD-3 Only (Type R2)

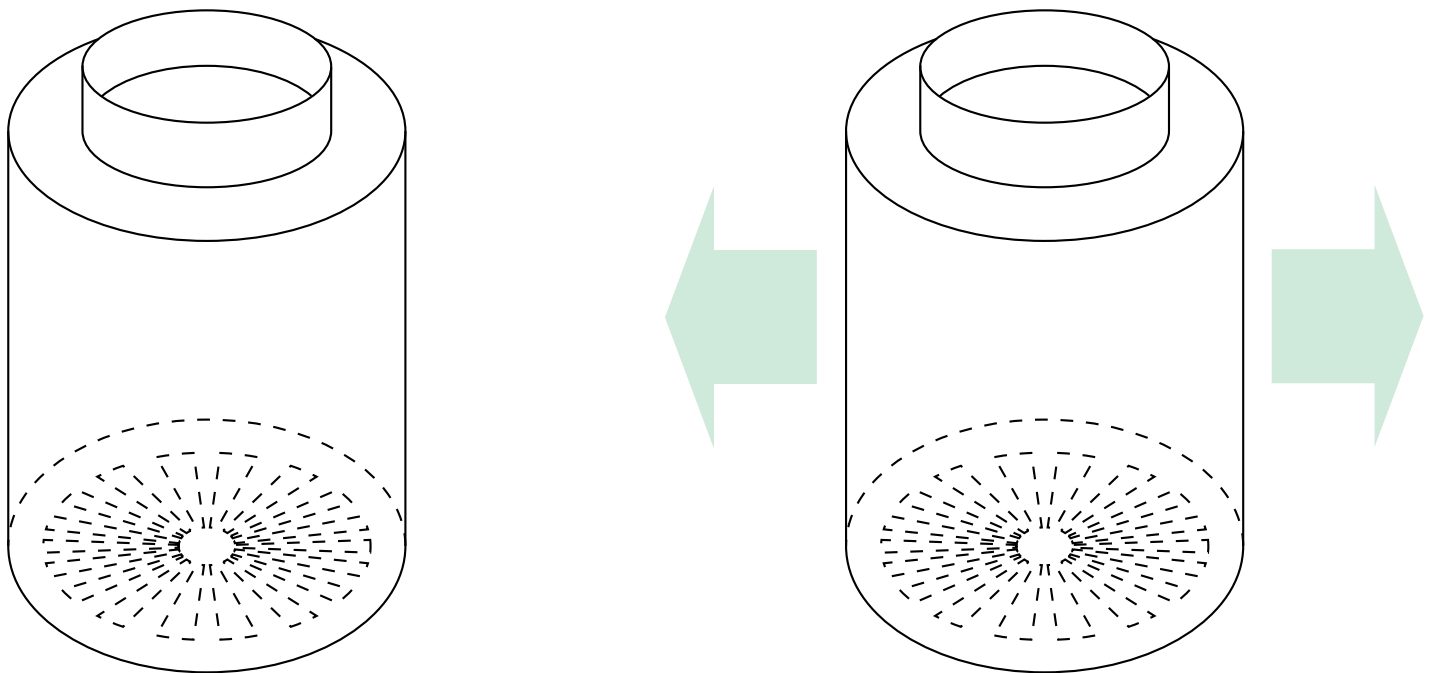

Volume control damper opened

Volume control damper closed

Application and Selection Guide

Typical Application Layout

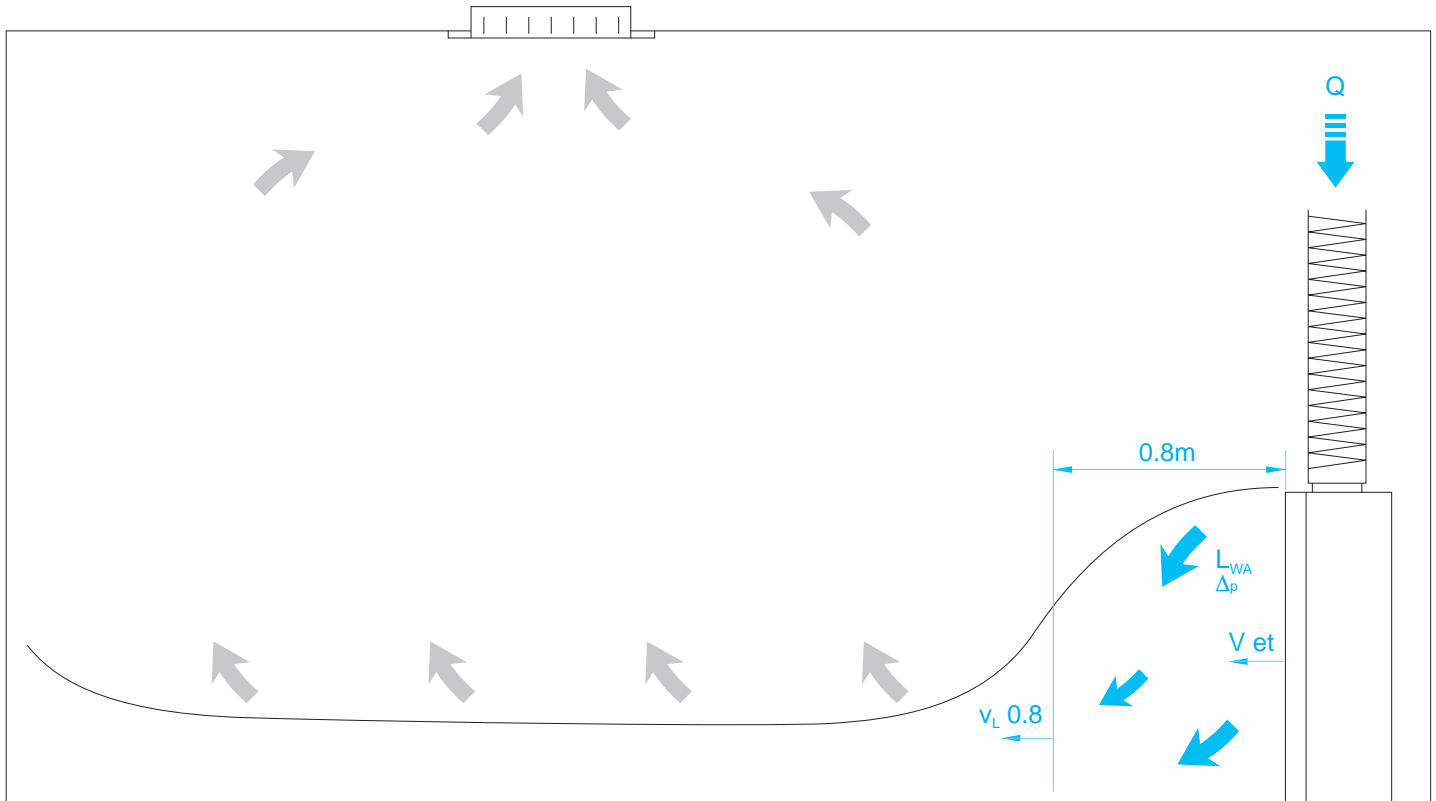

- Q (l/s)** Air flow rate.
- v_L (m/s)** Supplied air velocity at the throw distance $L=0.8$ m.
- v_{ef}** Effective discharge air velocity.
- Δt_z (K)** Temperature difference between supply and room air.
- Δt_L (K)** Temperature difference air jet and room temperature.
- Δp_t (Pa)** Pressure drop.
- L_{WA} (db(A))** Sound power level.

Codes for Correction Factors in Selection Guide

- F1:** Plain without filters
- F2:** Fitted with cone shaped bag filter
- F3:** Fitted with peripheral filter media
- F4:** Fitted with with both a cone bag filter and peripheral filter media
- F5:** With dividing rings
- F6:** Fitted with peripheral filter media and dividing rings

Selection Guide

SD - 1 Technical Data

Diagrams to determine the supplied air velocity of the throw distance L=0.8m

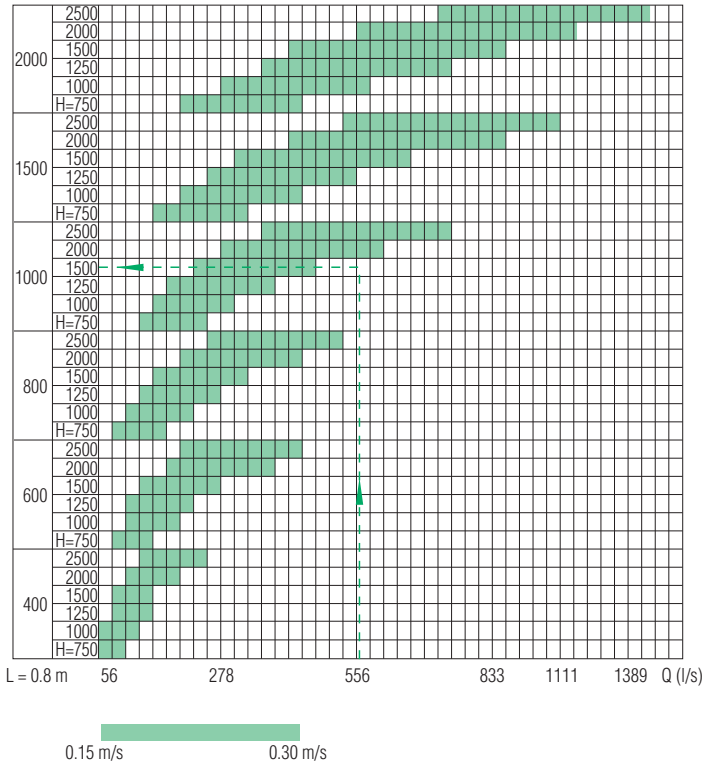

Pressure drop and noise level diagrams

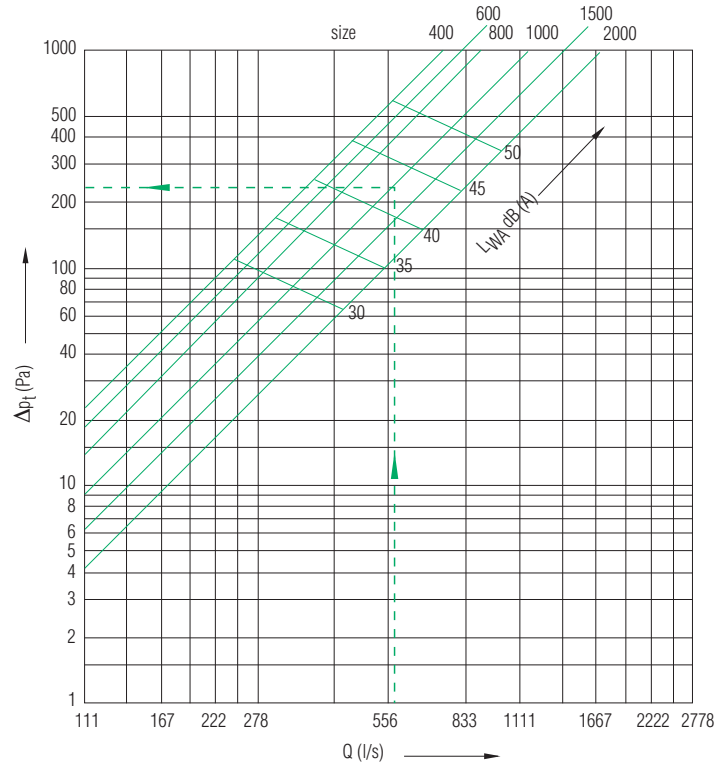

KF Correction Factor Table

Correction	Size	750	1000	1250	1500	2000	2500
Δp_t for the type F3	400	1.44	1.00	0.80	0.26	0.16	0.11
	600	1.10	1.00	0.96	0.28	0.26	0.25
	800	1.06	1.00	0.97	0.29	0.27	0.27
	1000	1.10	1.00	0.96	0.33	0.31	0.30
	1500	1.04	1.00	0.98	0.34	0.33	0.33
2000	1.02	1.00	0.99	0.38	0.38	0.37	
Δp_t for the type F1	400	0.55	0.51	0.50	0.05	0.04	0.04
	600	0.56	0.51	0.49	0.14	0.13	0.13
	800	0.93	0.93	0.93	0.26	0.26	0.26
	1000	0.90	0.89	0.89	0.28	0.28	0.28
	1500	0.96	0.95	0.95	0.32	0.32	0.32
2000	0.98	0.98	0.98	0.37	0.37	0.37	
Δp_t for the type F4	400	2.33	1.42	1.11	0.47	0.28	0.19
	600	1.30	1.11	1.03	0.33	0.28	0.26
	800	1.19	1.07	1.02	0.32	0.29	0.28
	1000	1.29	1.11	1.02	0.38	0.33	0.31
	1500	1.13	1.05	1.01	0.36	0.34	0.34
2000	1.06	1.02	1.01	0.39	0.38	0.38	

Size	400	600	800	1000	1500	2000
L(m)	0.214	0.406	0.502	0.718	1.066	1.400

Calculation of free area A_{ef} :

$$A_{ef} = L \times H \times 0.6944 \text{ (m}^2\text{)} \quad L - \text{from the table}$$

$$A_{ef} = L \times H \times 0.37 \text{ (m}^2\text{)} \quad \text{for the versions F1, F2, and F5 (without filter) and mantle perforation with round openings.}$$

Example calculations

$$Q = 556 \text{ l/s}$$

We select size 1000; H = 1500

$$A_{ef} = 0.718 \times 1.5 \times 0.6944 = 0.748 \text{ (m}^2\text{)}$$

$$v_{ef} = Q / A_{ef} = \frac{0.556}{0.748} = 0.74 \text{ m/s}$$

$$L_{WA} = 42 \text{ dB(A)}$$

Pressure drop:

Type F3

$$\Delta p_t = \text{from the diagram} \times \text{KF (for H = 1500)} = 230 \times 0.33 = 75.9 \text{ Pa}$$

Type F1

$$\Delta p_t = \text{from the diagram} \times \text{KF (for H = 1500)} = 230 \times 0.28 = 64.4 \text{ Pa}$$

Type F4

$$\Delta p_t = \text{from the diagram} \times \text{KF (for H = 1500)} = 230 \times 0.38 = 87.4 \text{ Pa}$$

Q (l/s) Air flow rate

v_L (m/s) Supplied air velocity at the throw distance L = 0.8m

Δp_t (Pa) Pressure drop

L_{WA} (dB (A)) Sound power level

Selection Guide

SD - 2 Technical Data

Diagrams to determine the supplied air velocity of the throw distance L=0.8m

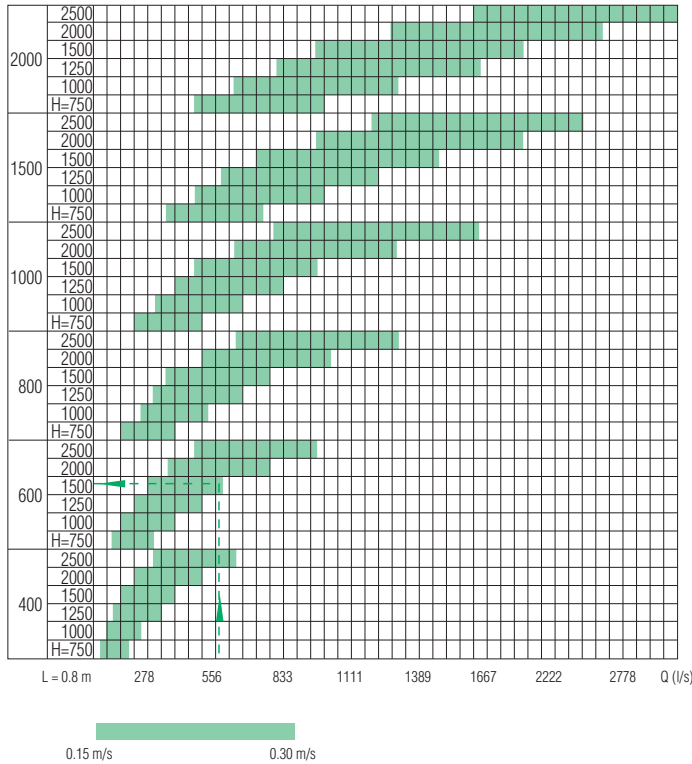

Pressure drop and noise level diagrams

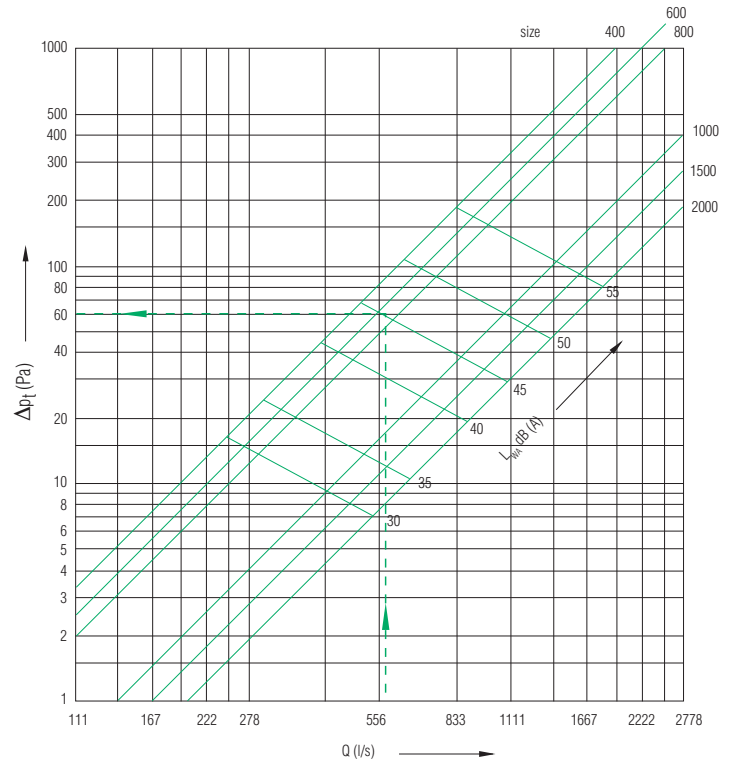

KF Correction Factor Table

Correction	Size	750	1000	1250	1500	2000	2500
Δpt for the type F3	400	1.43	1.00	0.81	0.28	0.18	0.13
	600	1.15	1.00	0.93	0.32	0.29	0.27
	800	1.08	1.00	0.97	0.35	0.33	0.33
	1000	1.30	1.00	0.87	0.33	0.26	0.23
	1500	1.13	1.00	0.94	0.36	0.33	0.32
Δpt for the type F1	2000	1.07	1.00	0.97	0.38	0.36	0.36
	400	0.56	0.52	0.51	0.07	0.07	0.06
	600	0.58	0.84	0.83	0.25	0.25	0.25
	800	0.92	0.92	0.91	0.32	0.31	0.31
	1000	0.69	0.67	0.66	0.18	0.18	0.18
Δpt for the type F4	1500	0.87	0.86	0.86	0.30	0.30	0.30
	2000	0.93	0.92	0.92	0.35	0.34	0.34
	400	2.30	1.48	1.11	0.19	0.29	0.21
	600	1.44	1.16	1.04	0.39	0.33	0.30
	800	1.23	1.08	1.02	0.39	0.35	0.34
	1000	1.91	1.33	1.08	0.47	0.34	0.28
	1500	1.38	1.14	1.03	0.42	0.36	0.34
	2000	1.21	1.08	1.02	0.41	0.36	0.37

Size	400	600	800	1000	1500	2000
L(m)	0.598	0.920	1.228	1.550	2.334	3.120

Calculation of free area A_{ef}:

$$A_{ef} = L \times H \times 0.6944 \text{ (m}^2\text{)} \quad L - \text{from the table}$$

$$A_{ef} = L \times H \times 0.37 \text{ (m}^2\text{)} \quad \text{for the versions F1, F2, and F5 (without filter) and mantle perforation with round openings.}$$

Example calculations

$$Q = 556 \text{ l/s}$$

We select size 600; H = 1500

$$A_{ef} = 0.92 \times 1.5 \times 0.6944 = 0.958 \text{ (m}^2\text{)}$$

$$v_{ef} = Q / A_{ef} = \frac{0.556}{0.958} = 0.58 \text{ m/s}$$

$$L_{WA} = 45 \text{ dB(A)}$$

Pressure drop:

Type F3

$$\Delta p_t = \text{from the diagram} \times \text{KF (for H = 1500)} = 60 \times 0.32 = 19.2 \text{ Pa}$$

Type F1

$$\Delta p_t = \text{from the diagram} \times \text{KF (for H = 1500)} = 60 \times 0.25 = 15.0 \text{ Pa}$$

Type F4

$$\Delta p_t = \text{from the diagram} \times \text{KF (for H = 1500)} = 60 \times 0.39 = 19.5 \text{ Pa}$$

Q (l/s) Air flow rate

v_L (m/s) Supplied air velocity at the throw distance L = 0.8m

Δp_t (Pa) Pressure drop

L_{WA} (dB (A)) Sound power level

Selection Guide

SD - 3 Technical Data

Diagrams to determine the supplied air velocity of the throw distance L=0.8m

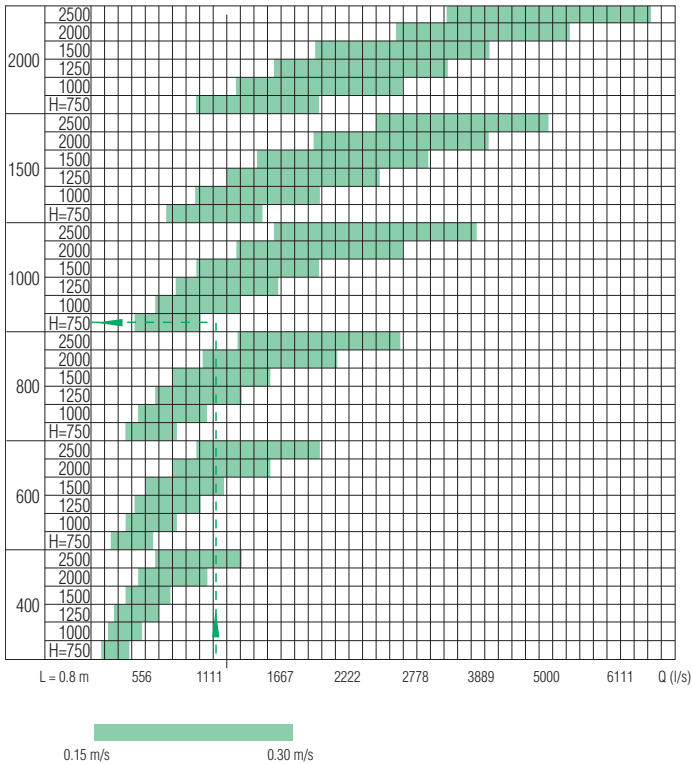

Pressure drop and noise level diagrams

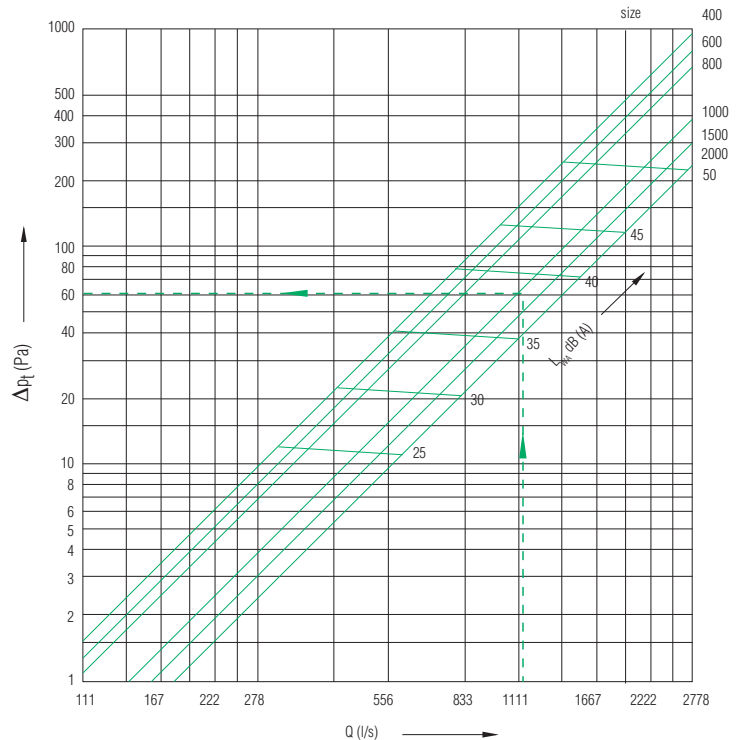

KF Correction Factor Table

Correction	Size	750	1000	1250	1500	2000	2500
Δpt for the type F3	400	1.47	1.00	0.79	0.36	0.26	0.21
	600	1.11	1.00	0.95	0.55	0.52	0.51
	800	1.05	1.00	0.98	0.61	0.59	0.59
	1000	1.05	1.00	0.98	0.19	0.18	0.17
	1500	1.02	1.00	0.99	0.22	0.21	0.21
	2000	1.01	1.00	1.00	0.23	0.22	0.22
Δpt for the type F1	400	0.51	0.48	0.46	0.14	0.13	0.13
	600	0.88	0.87	0.87	0.49	0.49	0.49
	800	0.95	0.94	0.94	0.58	0.58	0.58
	1000	0.95	0.95	0.95	0.17	0.17	0.17
	1500	0.98	0.98	0.98	0.21	0.21	0.21
	2000	0.99	0.99	0.99	0.22	0.22	0.22
Δpt for the type F4	400	2.42	1.52	1.12	0.59	0.38	0.29
	600	1.34	1.13	1.03	0.60	0.55	0.53
	800	1.15	1.06	1.01	0.63	0.61	0.60
	1000	1.14	1.05	1.01	0.21	0.19	0.18
	1500	1.05	1.02	1.00	0.22	0.22	0.21
	2000	1.03	1.01	1.00	0.23	0.23	0.22

Calculation of free area A_{ef} :

$$A_{ef} = A \times \pi \times H \times 0.6944 \text{ (m}^2\text{) } A - \text{size (m)}$$

$A_{ef} = A \times \pi \times H \times 0.37 \text{ (m}^2\text{) for the versions F1, F2, and F5 (without filter) and mantle perforation with round openings.}$

Example calculations

$$Q = 1111 \text{ l/s}$$

We select size 1000; H = 750

$$A_{ef} = 1 \times \pi \times 0.75 \times 0.6944 = 1.64 \text{ (m}^2\text{)}$$

$$v_{ef} = Q / A_{ef} = \frac{1.111}{1.64} = 0.68 \text{ m/s}$$

$$L_{WA} = 37 \text{ dB(A)}$$

Pressure drop:

Type F3

$$\Delta p_t = \text{from the diagram} \times \text{KF (for H = 750)} = 60 \times 1.05 = 63.0 \text{ Pa}$$

Type F1

$$\Delta p_t = \text{from the diagram} \times \text{KF (for H = 750)} = 60 \times 0.95 = 57.0 \text{ Pa}$$

Type F4

$$\Delta p_t = \text{from the diagram} \times \text{KF (for H = 750)} = 60 \times 1.14 = 68.4 \text{ Pa}$$

Q (l/s) Air flow rate

v_L (m/s) Supplied air velocity at the throw distance L = 0.8m

Δp_t (Pa) Pressure drop

L_{WA} (dB (A)) Sound power level

Selection Guide

SD - 6 Technical Data

Diagrams to determine the supplied air velocity of the throw distance L=0.8m

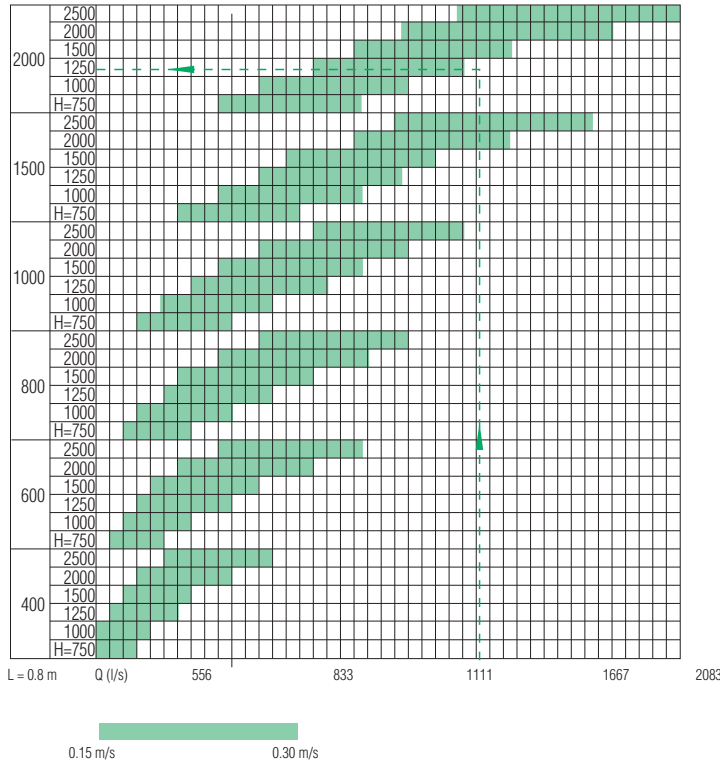

Pressure drop and noise level diagrams

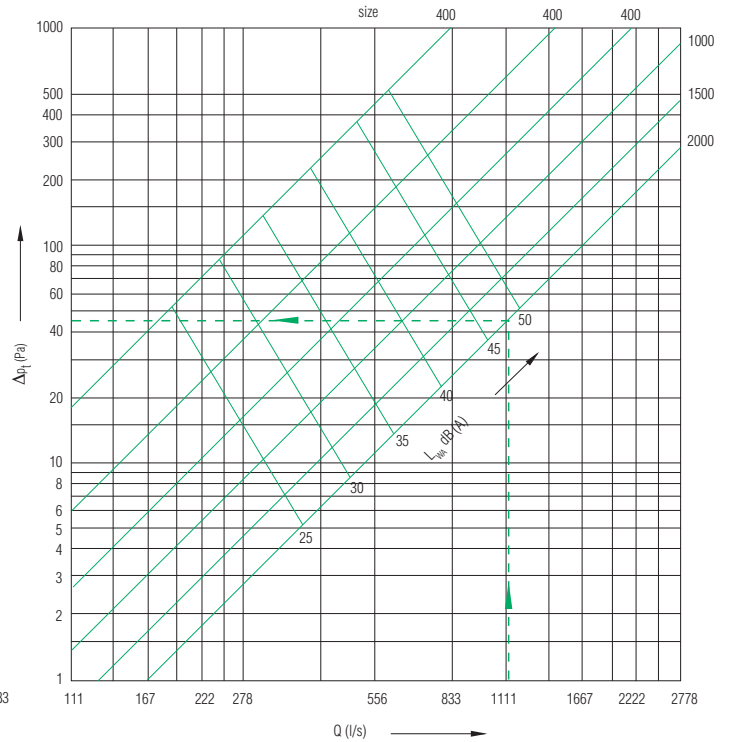

KF Correction Factor Table

Correction	Size	750	1000	1250	1500	2000	2500
Δpt for the type F3	400	1.11	1.00	0.95	0.93	0.90	0.89
	600	1.14	1.00	0.94	0.90	0.87	0.86
	800	1.18	1.00	0.92	0.88	0.83	0.82
	1000	1.22	1.00	0.90	0.85	0.79	0.77
	1500	1.18	1.00	0.92	0.88	0.84	0.82
Δpt for the type F1	2000	1.17	1.00	0.92	0.89	0.85	0.83
	400	0.89	0.88	0.88	0.88	0.87	0.87
	600	0.85	0.84	0.84	0.84	0.83	0.83
	800	0.81	0.80	0.79	0.79	0.79	0.78
	1000	0.77	0.75	0.74	0.74	0.74	0.83
Δpt for the type F4	1500	0.81	0.80	0.79	0.79	0.79	0.78
	2000	0.83	0.81	0.81	0.80	0.80	0.73
	400	1.32	1.12	1.03	0.98	0.93	0.79
	600	1.42	1.16	1.04	0.97	0.91	0.80
	800	1.55	1.20	1.05	0.96	0.88	0.91
	1000	1.68	1.25	1.06	0.95	0.85	0.88
	1500	1.55	1.20	1.05	0.96	0.88	0.85
	2000	1.51	1.19	1.04	0.97	0.89	0.86

Calculation of free area A_{ef}:

$$A_{ef} = A \times H \times 0.6944 \text{ (m}^2\text{) } A - \text{Size (m)}$$

A_{ef} = A x H x 0.37 (m²) for the versions F1, F2, and F5 (without filter) and mantle perforation with round openings.

Example calculations

$$Q = 1111 \text{ l/s}$$

We select size 2000; H = 1250

$$A_{ef} = 2 \times 1.25 \times 0.6944 = 1.74 \text{ (m}^2\text{)}$$

$$v_{ef} = Q / A_{ef} = \frac{1.111}{1.74} = 0.64 \text{ m/s}$$

$$L_{WA} = 48 \text{ dB(A)}$$

Pressure drop:

Type F3

$$\Delta p_t = \text{from the diagram} \times \text{KF (for H = 1250)} = 45 \times 0.92 = 41.4 \text{ Pa}$$

Type F1

$$\Delta p_t = \text{from the diagram} \times \text{KF (for H = 1250)} = 45 \times 0.81 = 36.4 \text{ Pa}$$

Type F4

$$\Delta p_t = \text{from the diagram} \times \text{KF (for H = 1250)} = 45 \times 1.04 = 46.8 \text{ Pa}$$

Q (l/s) Air flow rate

v_L (m/s) Supplied air velocity at the throw distance L = 0.8m

Δp_t (Pa) Pressure drop

L_{WA} (dB (A)) Sound power level

Dimensions

SD-1 Corner

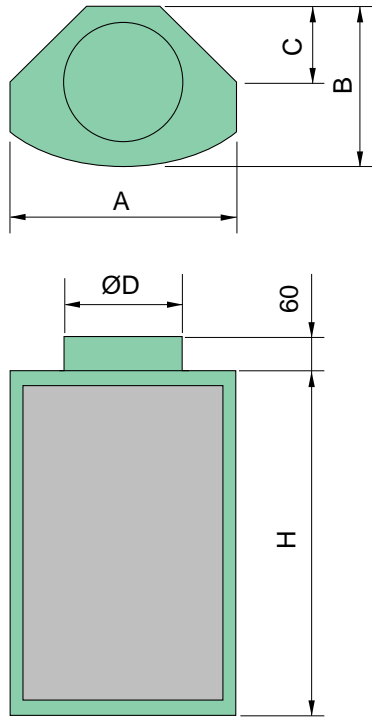

Size	A	B	C	ØD	H
400	283	180	100	123	750
600	424	275	135	148	1000
800	566	300	150	178	1250
1000	707	400	200	198	1500
1500	1061	450	220	248	2000
2000	1414	700	350	298	2500

SD-2 Semi Circular

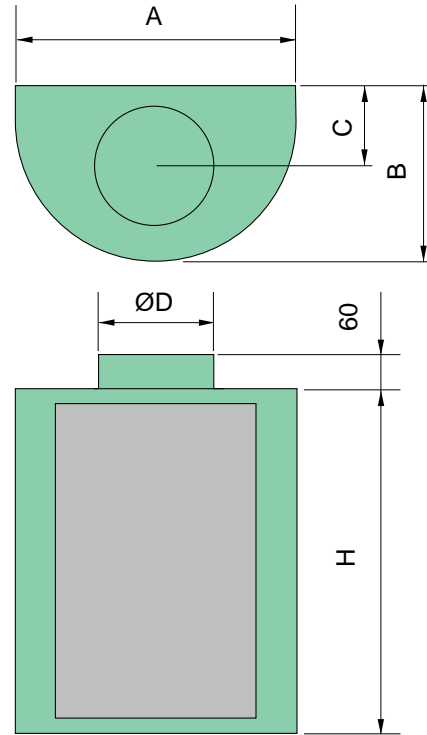

Size	A	B	C	ØD
400	400	320	150	178
600	600	470	230	198
800	800	570	250	248
1000	1000	620	280	298
1500	1500	870	350	348
2000	2000	1120	430	398

SD-3 Circular

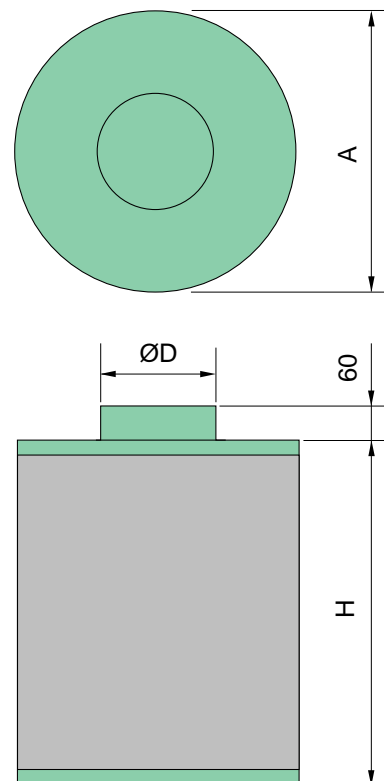

Size	A	ØD	H
400	400	248	750
600	600	298	1000
800	800	348	1250
1000	1000	398	1500
1500	1500	498	2000
2000	2000	548	2500

Dimensions

SD-6 Rectangular

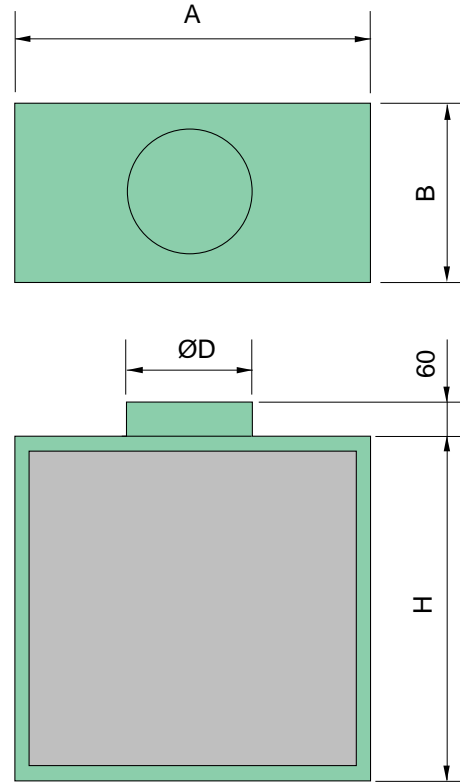

Size	A	B	ØD	H
400	400	200	148	750
600	600	250	178	1000
800	800	300	198	1250
1000	1000	350	248	1500
1500	1500	400	298	2000
2000	2000	450	313	2500

Ordering Information

Example

Type	Version	Regulation	(Standard) Size	(Standard) Height
SD-3	F1	R1	400	750
SD-1 Corner	F1 – without filters.	R1 – Regulation with blades (available with Type SD-3)	400	750
SD-2 Semi-cylindrical	F2 – with the filter bag.		600	1000
SD-3 Cylindrical	F3 – with the peripheral filter.		800	1250
SD-6 Rectangular	F4 – with the filter bag and the peripheral filter.	R2 – Regulation with a flow control damper (available with Type SD-3).	1000	1500
	F5 – With dividing rings without filters.		1500	2000
	F6 – With dividing rings and peripheral filter.		2000	2500
	Note: Please refer to page 3 for type of perforated mesh facia.			

Important Note: All orders must be addressed to Air Diffusion, Ruskin Air Management Limited.

**Ruskin Air Management Limited
is a BS EN ISO 9000 registered
company.**

The statements made in this brochure or by our representatives in consequence of any enquiries arising out of this document are given for information purposes only. They are not intended to have any legal effect and the company is not to be regarded as bound thereby. The company will only accept obligations which are expressly negotiated for and agreed and incorporated into a written agreement made with its customers.

Due to a policy of continuous product development the specification and details contained herein are subject to alteration without prior notice.

**Comprehensive and detailed information
is available for all Air Diffusion products.
Visit our website at www.air-diffusion.co.uk**

Ruskin Air Management Limited



Stourbridge Road, Bridgnorth, Shropshire,
WV15 5BB England.
Tel: 01746 761921
Fax: 01746 760127
Email: sales@air-diffusion.co.uk
Website: www.air-diffusion.co.uk

Air Diffusion

Grilles Diffusers Louvres Chilled Beams