

# High Induction Slot Diffusers

Models LD13, LD130, LD14 and LD140

## Features

- 2 Slot Widths
- 2 Flange Styles
- 1 to 4 Slots
- Aluminium Frame Construction
- Cylinder Inner Deflectors
- Swivel Discharge Adjustment
- Matching Plenum Boxes

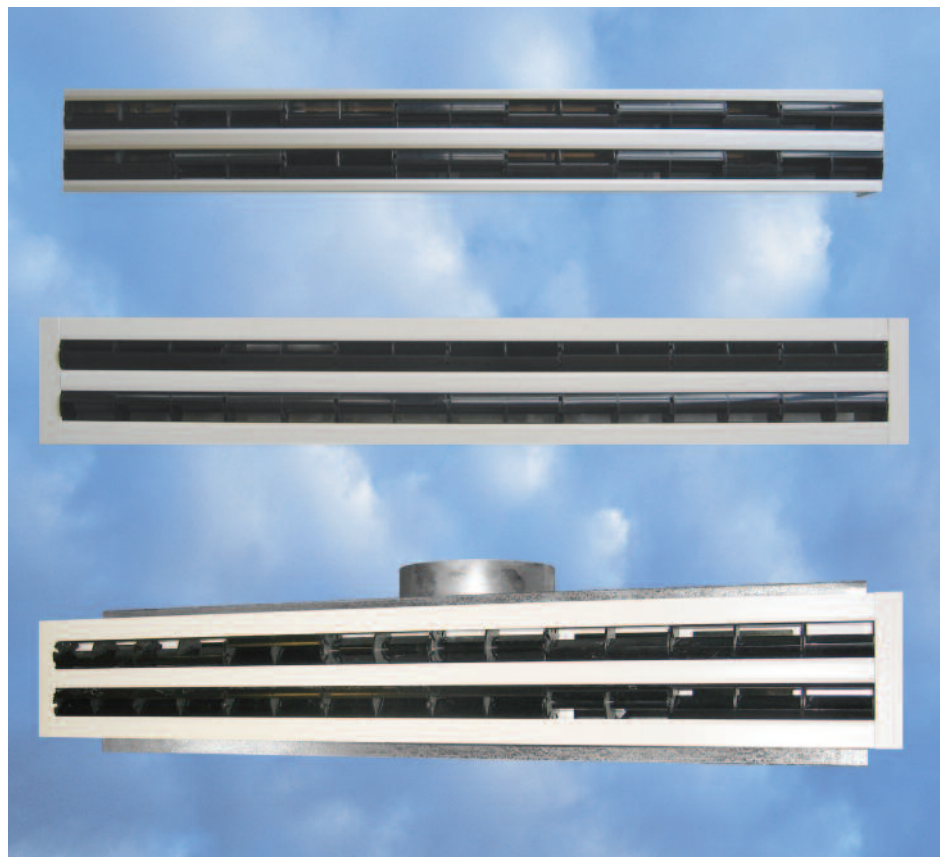

# Air Diffusion

Grilles Diffusers Louvres Chilled Beams

Ruskin Air Management Limited  
[www.ruskinuk.co.uk](http://www.ruskinuk.co.uk)

### Contents

---

	<b>Page</b>
Contents	Page 2
Introduction	Page 3
Specification, Diffuser and Air Discharge Patterns	Page 4
End Flanges, Corner and Angle Section	Page 5
Performance Guide	Pages 6 - 9
Installation Guide and Dimensions – Diffuser	Page 10
Dimensions – Diffuser	Page 11
Ordering Information – Diffuser	Page 12
Specification – Plenum Boxes	Page 13
Dimensions - Plenum Boxes	Page 14
Installation and Ordering Information – Plenum Boxes	Page 15

## Introduction

### Models LD13, LD130, LD14 & LD140 Swivel Slot Diffusers

In our High Induction Slot range there are two slot widths 15mm or 26mm and both are available with either a flanged or flangeless frame.

Models LD13 and LD130 have a 15mm slot width, whereas Models LD14 and LD140 have a 26mm slot width. It is important to remember that models LD 13 and LD 14 have a flanged frame whilst the models LD 130 and LD 140 have a flangeless frame.

Each diffuser incorporates an adjustable inner cylindrical deflector, which, by simply swivelling gives a full 360° range of air supply adjustment options, left, right and vertical discharge or a combination of all three from a single diffuser. The cylindrical deflectors also provide air control and shut off if required.

The High Induction Slot diffusers are suitable for mounting heights of 2.5 to 4.0 metres and may be used for heating or cooling applications. A high induction rate and a rapid decrease of temperature difference means these diffusers are ideal for use in most air distribution system designs.

Available in 1, 2, 3 or 4 slot widths, the maximum standard length of diffuser is 2 metres, although individual diffusers can be joined together to form longer sections. Corner sections and angle pieces may also be supplied to maintain a continuous appearance.

Purpose designed matching plenum boxes simplifies installation and ensures diffuser characteristics for optimum performance.

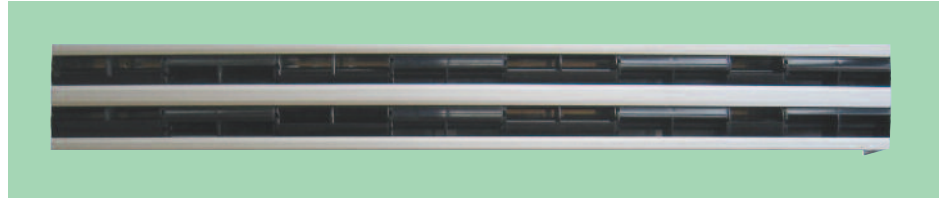

LD 14 - 2 Slot with End Plates

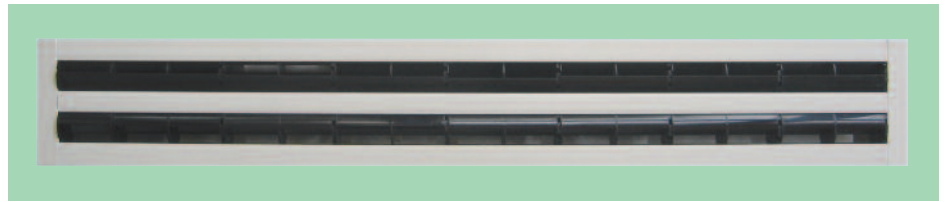

LD 14 - 2 Slot with End Flanges

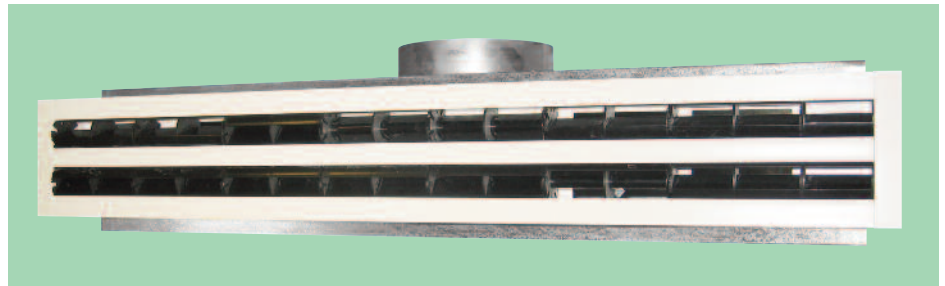

LD 14 - 2 Slot with End Flanges and Plenum Box



LD 14 - 4 Slot with End Flanges

### Specification - Diffuser

<b>Materials</b> Extruded Aluminium with inner cylinders from recycled plastics.	<b>Slot Sizes</b> 15mm - LD13 or LD130 26mm - LD14 or LD140.	<b>Flange Sizes</b> LD13 - 12.5mm Flange. LD14 - 12.5mm Flange. LD130 - 12.5mm Flangeless Border LD140 - 5mm Flangeless Border	<b>Finish</b> Standard finish is Anodised Aluminium.	<b>Optional Finish</b> White PPC RAL9010 (20% Gloss), other finishes available on request.	<b>Inner Cylinders</b> Standard finish is either Black or White (If colour not stated on order then Black cylinders will be supplied).	<b>Fixings</b> Diffuser to plenum standard is Type Z concealed cross member fixing.	<b>Optional Fixings</b> Type 'R' Hanger Brackets (see page 6).
---	--	--	---	---	---	--	---

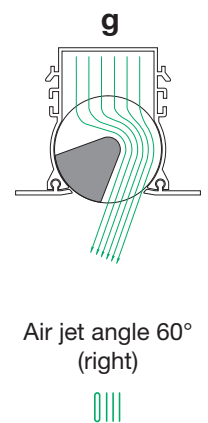
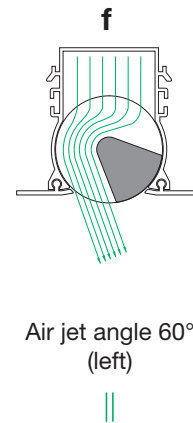
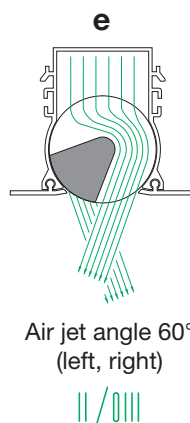
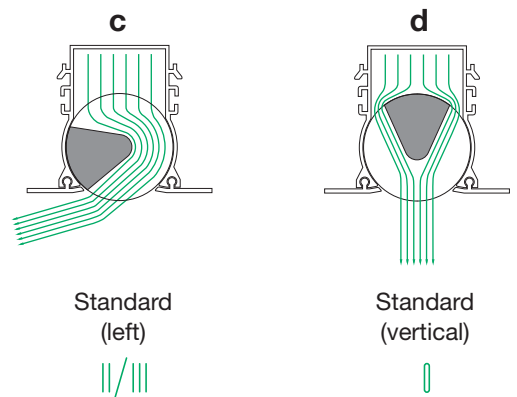
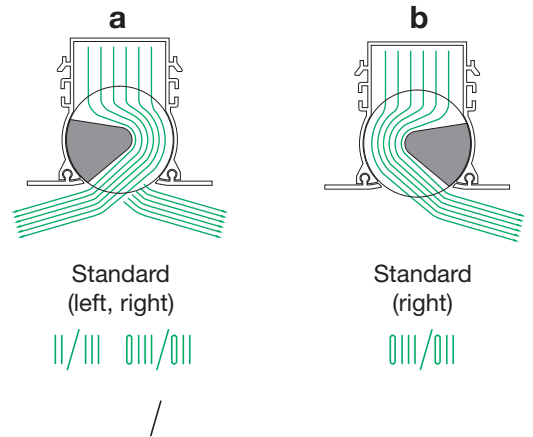
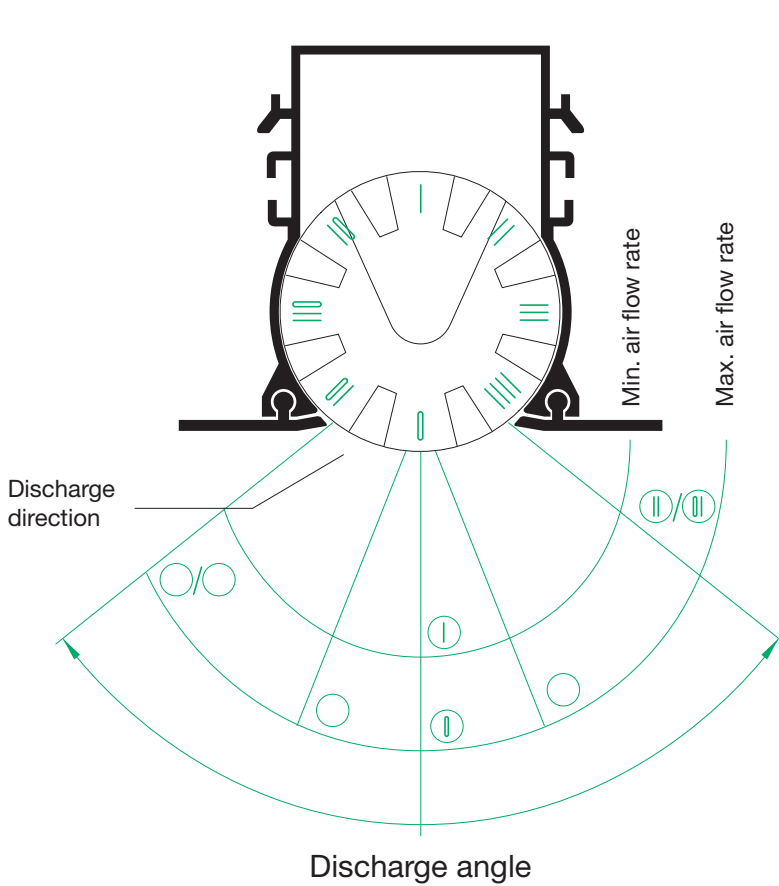

## End Flanges and End Plates

### 1. End Flange

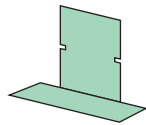
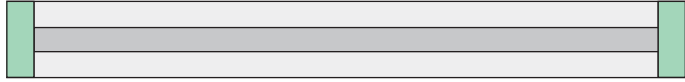

E/ET

### 2. End Plate

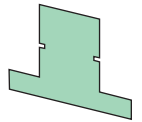
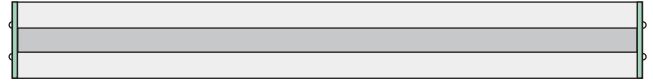

F/FT

### End Seals

End seals are components of the diffuser face plate. They are available in two designs:-

1. as a angle piece (E – on both ends, ET – on one end only) or
2. plates (F– on both ends, FT– on one end only). F and FT end plates only on models LD130 and LD140.

## Corner and Angle Sections

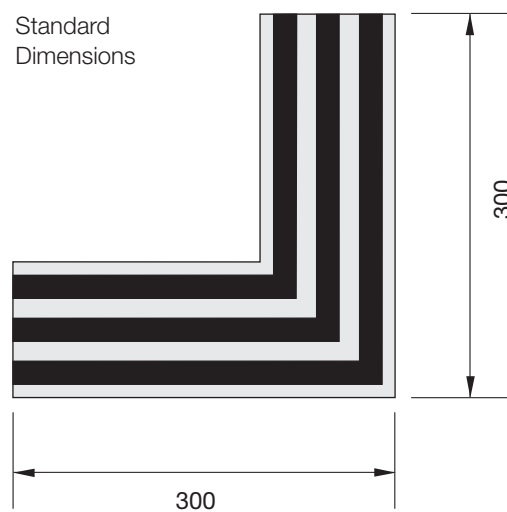
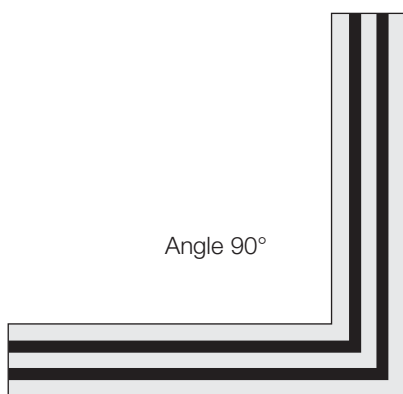

### Slot diffuser face plate designs

Slot diffuser face plates are made of linear or angular ended sections, which allow the diffusers to be joined at different angles. Angular ended sections are not fitted with air direction controls.

**Note:** Other angle sections by special request.

### Performance Guide - Model LD13 – 15mm wide slot

#### Selection Table

	Vol L/s/m	Pressure Pa	Noise NR <sub>LpA</sub>	Throw L <sub>T</sub> m	V <sub>T</sub> m/s
<b>LD13 – 1 slot</b>					
	11	1.5	8	1.2	0.1
	14	2	8	2	0.1
	28	5.8	15	3	0.25
	33	7.2	20	3.5	0.25
	39	9.8	23	5	0.25
	60	25	30	7	0.25
	85	42.5	40	8	0.25
<b>LD13 – 2 slot</b>					
	28	2	8	2	0.15
	42	4.6	10	4	0.25
	56	7.6	17	7	0.25
	78	13	24	9	0.25
	100	21	30	10	0.25
	125	35	40	12	0.25
<b>LD13 – 3 slot</b>					
	42	2.5	9	1.6	0.2
	56	4	10	5	0.25
	69	5.5	15	7	0.25
	111	15.3	26	12	0.25
	130	28	30	13	0.25
	170	45	40	14	0.25
<b>LD13 – 4 slot</b>					
	56	2.4	10	3	0.20
	70	3.7	13	6	0.25
	83	5.1	16	9	0.25
	140	14.3	26	16.5	0.25
	150	17	30	>17	>0.45
	205	35	40	>17	>0.5

The data is based on the following parameters: -

1. Diffuser flush mounted to a ceiling height of 2.7m.
2. Active length of 1m long to one-way horizontal blow.
3. Throws distances are based on Temp differential of 10° C cooling.
4. Sound Levels (NR) are based on average room absorption of 9dB.

Active length correction factors to the selection table.

Length (m)	Noise (NR)	Pd (pa)
1.0	0	0
1.2 - 1.7	+2	x 1.20
1.8 - 2.0	+4	x 1.8

Calculated correction factors for Alternate throws (m)

Alternate Sided	L <sub>T</sub> x 0.4
-----------------	----------------------

Calculated correction factors for two way Horizontal discharge (m)

Two Sided	L <sub>T</sub> x 0.6
-----------	----------------------

# Performance Guide - Model LD13

## Select Diagram - Slot Diffuser LD13

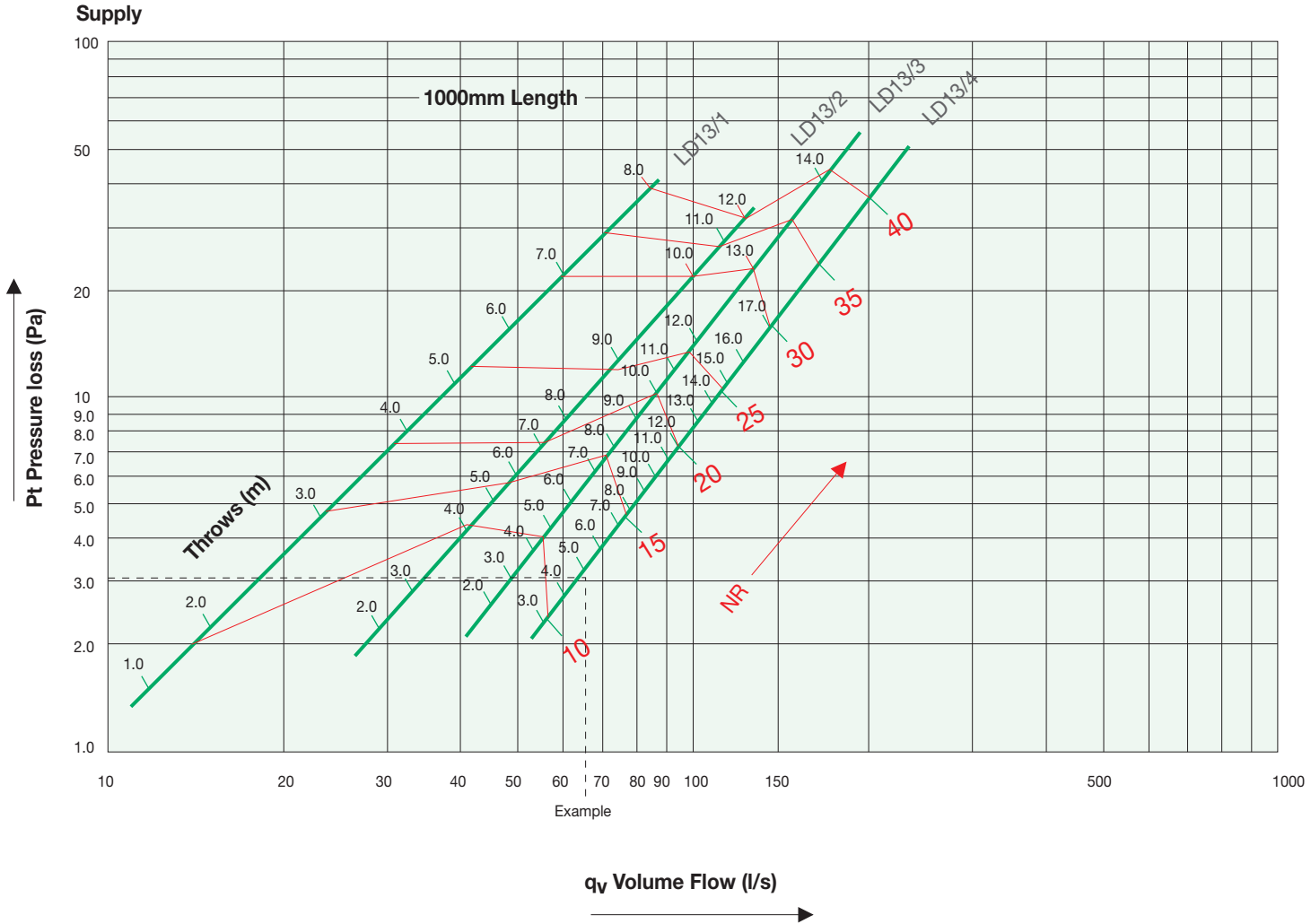

**Selection Example:-**

**Requirement:**

- LD13/4 Slot; Air discharge - Alternate Direction (Horizontal)
- qv<sub>total</sub> = 100 l/s
- Length = 1500mm
- Noise = 17NR Max.
- Throw = 5m @ 0.25m/s Terminal Velocity and -10° C
- Pressure = 7Pa Max.

**Selection:**

- LD13/4 Slot
- qv = 67 l/s.m
- Noise = Using Active length Correction Factors  
12 + 2 = 14NR
- Throw LT = 4.9m
- dPa = Using Active length Correction Factors  
3.1 x 1.2 = 3.7Pa

### Performance Guide - Model LD14 – 26mm wide slot

#### Selection Table

	Vol L/s/m	Pressure Pa	Noise NR <sub>LpA</sub>	Throw m	Vt m/s
<b>LD14 – 1 slot</b>					
	22	2.8	8.0	2.0	0.25
	28	3.4	8.0	3.5	0.25
	42	5.5	15.0	6.0	0.25
	50	6.3	19.0	8.0	0.25
	56	8.8	21.0	9.5	0.25
	75	11.0	25.0	11.7	0.35
	86	16.0	30.0	13.6	0.50
	115	18.0	40.0	>14.0	>0.50
<b>LD14 – 2 slot</b>					
	42	1.8	8.0	4.0	0.25
	56	2.5	10.0	6.0	0.25
	78	4.3	16.0	10.0	0.25
	97	5.8	20.0	12.7	0.25
	111	7.1	23.0	15.7	0.50
	125	11.0	25.0	>17.0	>0.50
	150	13.0	30.0	>17.0	>0.50
	200	19.0	40.0	>17.0	>0.50
<b>LD14 – 3 slot</b>					
	69	1.5	8.0	6.0	0.25
	100	1.7	12.0	10.0	0.25
	111	2.0	16.0	12.0	0.30
	125	2.4	18.0	13.0	0.30
	140	3.0	20.0	15.5	0.50
	160	3.6	25.0	>17.0	>0.50
	185	5.0	30.0	>17.0	>0.50
	210	6.0	40.0	>17.0	>0.50
<b>LD14 – 4 slot</b>					
	78	1.0	8.0	6.0	0.20
	111	1.6	14.0	10.0	0.25
	140	2.0	16.0	13.0	0.35
	167	2.6	19.0	16.0	0.50
	222	4.3	25.0	>17.0	>0.50
	265	6.0	30.0	>17.0	>0.50
	320	7.0	40.0	>17.0	>0.50

The data is based on the following parameters: -

1. Diffuser flush mounted to a ceiling height of 2.7m.
2. Active length of 1m long to one-way horizontal blow.
3. Throws distances are based on Temp differential of 10°C cooling.
4. Sound Levels (NR) are based on average room absorption of 9dB.

#### Active length correction factors to the selection table.

Length (m)	Noise (NR)	Pd (pa)
1.0	0	0
1.2 - 1.7	+2	x 1.20
1.8 - 2.0	+4	x 1.8

#### Calculated correction factors for Alternate throws (m)

Alternate Sided	$L_T \times 0.4$
-----------------	------------------

#### Calculated correction factors for two way Horizontal discharge (m)

Two Sided	$L_T \times 0.6$
-----------	------------------

# Performance Guide - Model LD14

## Select Diagram - Slot Diffuser LD14

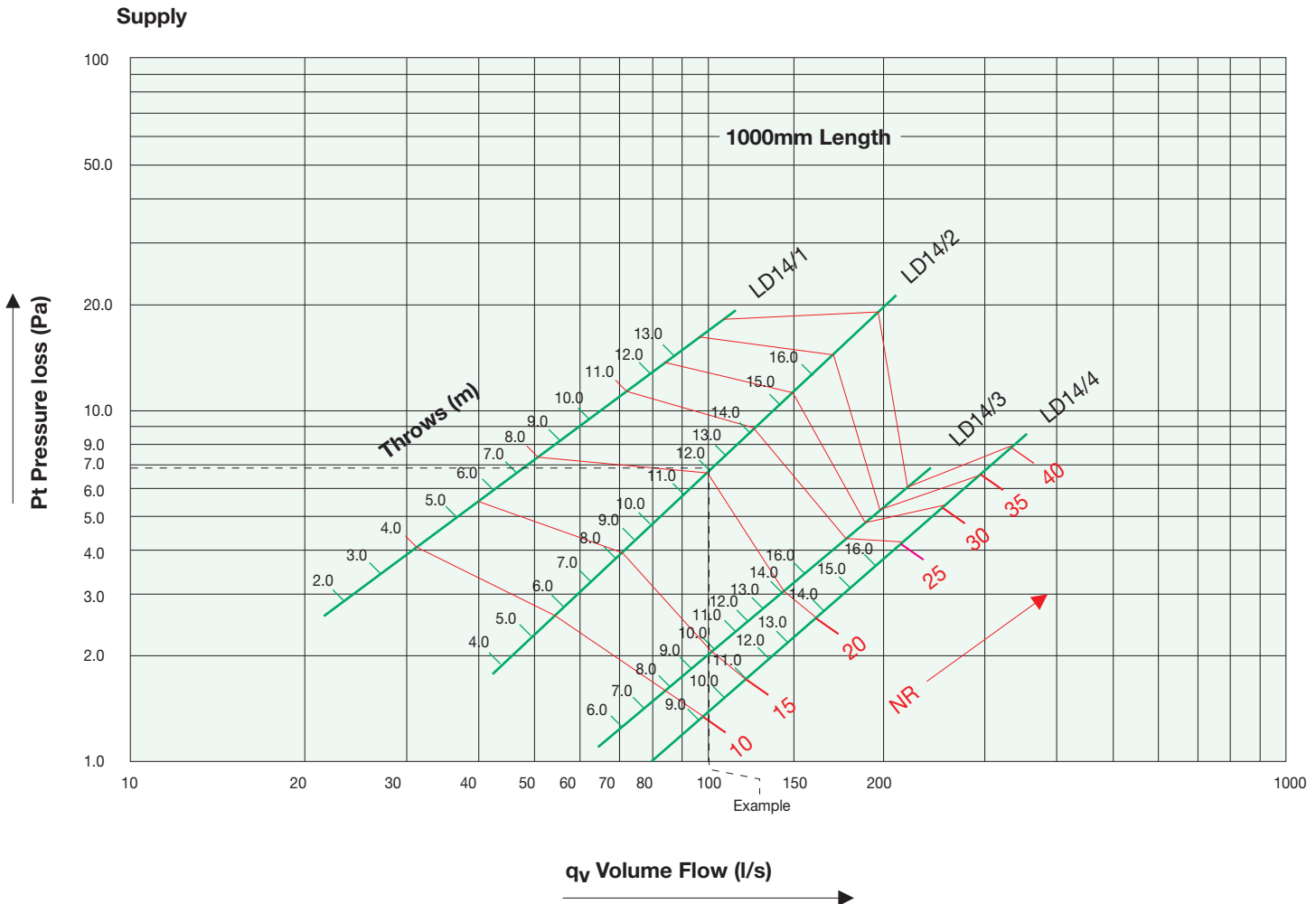

### Selection Example:-

**Requirement:**

LD14/2 Slot; Air discharge - Alternate Direction (Horizontal)

qv total = 100 l/s

Length = 1000mm

Noise = 22NR Max.

Throw = 5m @ 0.25m/s Terminal Velocity and -10° C

Pressure = 7Pa Max.

**Selection:**

LD14/2 Slot

qv = 100 l/s.m

Noise = 21NR

Throw LT = 11.8 x 0.4 Using Alternate Horiz. throws  
Correction factor = 4.8m

dPa = 6.7Pa

## Installation Guide, Dimensions - Diffuser

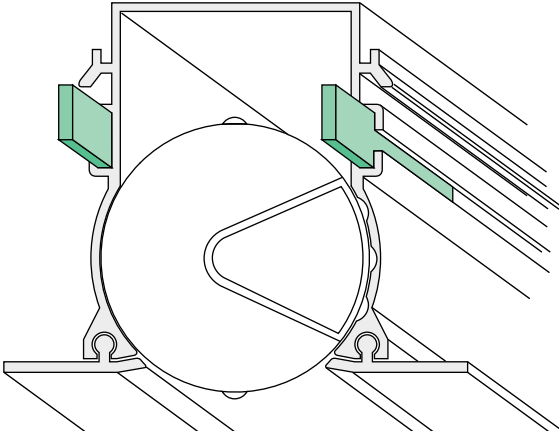

**Joining together in length**  
Joining in length requires connecting plates (the total length of combined diffusers is unlimited)

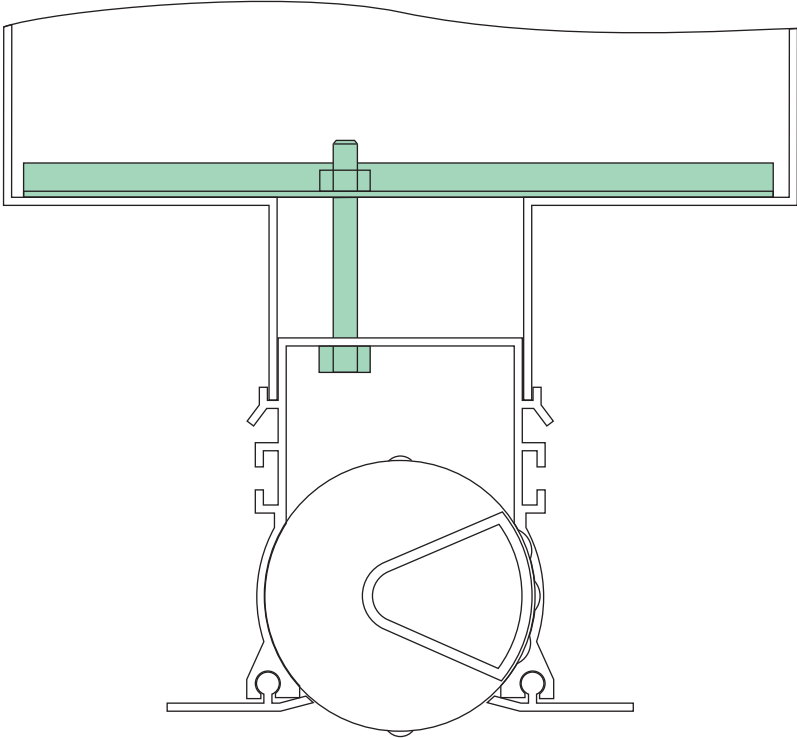

Standard diffuser installation using Type 'Z' cross member fixing bar into plenum

### Dimensions (Longitudinal Section)

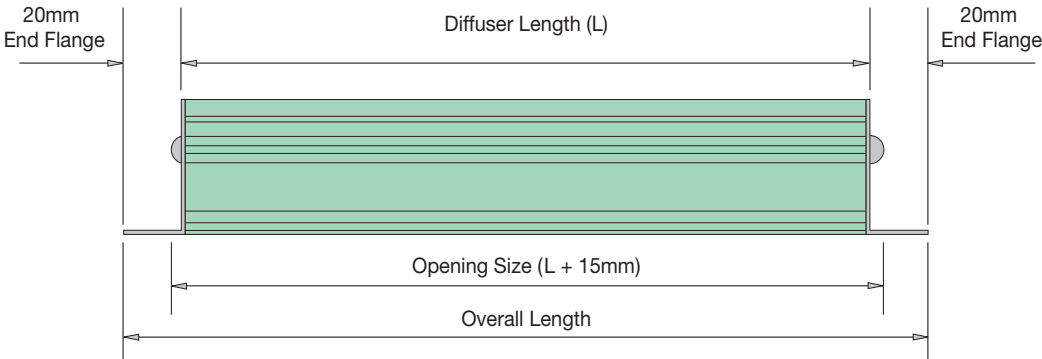

# Dimensions

**LD 13/2**

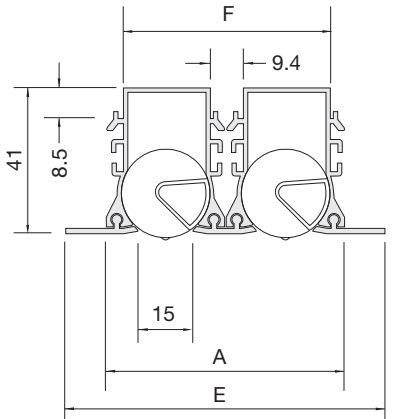

Installation openings:  $(A + 5) \times (L + 15)$

**LD 14/2**

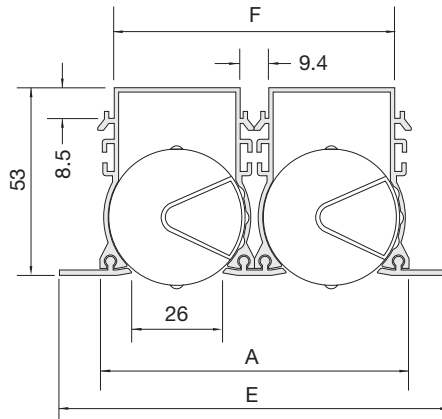

Installation openings:  $(A + 5) \times (L + 15)$

**LD 13**

	A	E	F
1 Slot	33	57.5	24.4
2 Slot	67	92	58.2
3 Slot	101	126.5	92.0
4 Slot	135	161.5	125.8

**LD 14**

	A	E	F
1 Slot	44	69	35.3
2 Slot	89	115	80
3 Slot	133	161.5	124.7
4 Slot	178	206.5	169.4

**LD 13 with Flange : Overall Flange Dimensions**

LD 13  
1 Slot

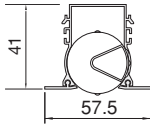

LD 13  
2 Slot

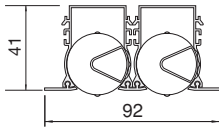

LD 13  
3 Slot

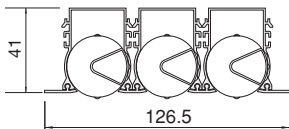

LD 13  
4 Slot

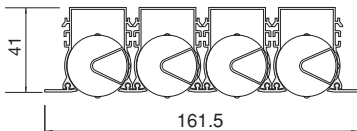

**LD 14 with Flange : Overall Flange Dimensions**

LD 14  
1 Slot

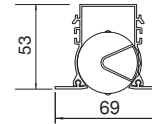

LD 14  
2 Slot

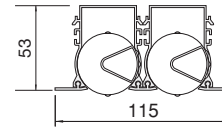

LD 14  
3 Slot

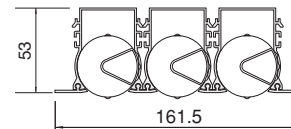

LD 14  
4 Slot

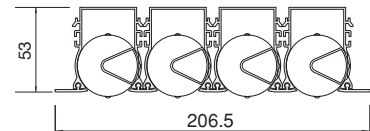

**LD 130 No Flange : Overall Flange Dimensions**

LD-130  
1 Slot

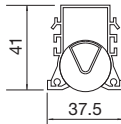

LD-130  
2 Slot

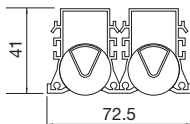

LD-130  
3 Slot

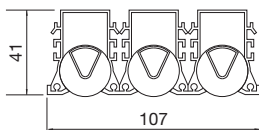

LD-130  
4 Slot



**LD 140 No Flange : Overall Flange Dimensions**

LD-140  
1 Slot

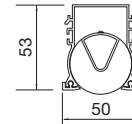

LD-140  
2 Slot

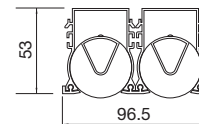

LD-140  
3 Slot

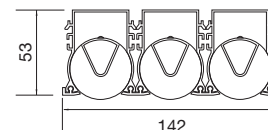

LD-140  
4 Slot

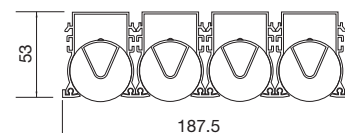

### Ordering Information - Diffuser

#### Type of Discharge Set Ups

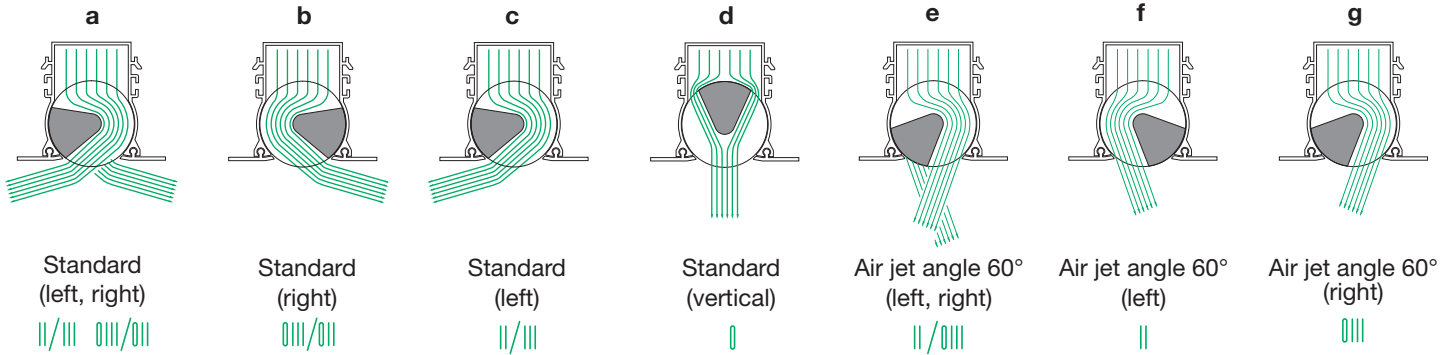

#### Example

Style	No. of Slots	Ends	Fixing	Frame Finish	Deflector Finish	Type of Discharge	Diffuser Length
LD13	2	E	Z	Standard (1)	Black	C	1500

- 1 – 1 slot
- 2 – 2 slot
- 3 – 3 slot
- 4 – 4 slot

- Z** Standard - secret fixing with cross member bracket secured onto plenum box
- R** Hanger Brackets

Black or White  
(Black supplied as standard if not confirmed on order)

Style	Slot Width	Ends	Fixing	Frame Finish	Deflector Finish	Type of Discharge
LD13	15mm slot 12mm flanged frame	<b>E</b> End flanges on both ends	<b>Z</b> Standard - secret fixing with cross member bracket secured onto plenum box	<b>Standard (1)</b> Anodised Aluminium	<b>Black</b>	<b>a</b>
LD 130	15mm slot 5mm flangeless frame	<b>ET</b> End flange on one end only	<b>R</b> Hanger Brackets	<b>Option (83)</b> White PPC RAL9010 (20% gloss) with other finishes also available on request (Options as additional cost items)	<b>Black</b>	<b>b</b>
LD14	26mm slot 12mm flanged frame	<b>F</b> End plate on both ends				<b>c</b>
LD140	26mm slot 5mm flangeless frame	<b>FT</b> End plate on one end only				<b>d</b>
		<b>Note:</b> 'F' and 'FT' only on LD130 and LD140				<b>e</b>
						<b>f</b>
						<b>g</b>

**Important Note:** If the overall size is critical then it must be clearly stated on the order. All orders must be addressed to AIR DIFFUSION, Ruskin Air Management Limited.

**Note:** Redesign may occur which supersedes the information in this brochure.

# Plenum Box Specification

## Plenum Boxes

Supplied unlined as standard with side entry spigot.

Plenum boxes can be supplied internally lined with 12mm class "O" foam at extra cost. Apply to sales office for price.

## Specifications

### Material

Standard is a minimum of 0.7mm thick galvanised or zinc coated steel.

### Construction

Plenum boxes are generally fabricated in 3 sections having tray ends, which are either mechanically joined or spot welded to form an airtight seal. Flush ends (no tray indents) are also available. As standard, spigots are side entry and located centrally. All boxes are supplied with plain edges, as standard, (F0 fixing). Equalising mesh grid fitted a standard.

### Standard Installation Method

The tray ends of the plenum box incorporate a 15mm indent, on each side to allow for 8mm drop rod fixings, which gives space for holes to be drilled (by others) without disturbing the active section.

### Installation Options

Fixing lugs can be factory fitted if preferred or special fixing methods (by others) may be used.

For plenum boxes having flush ends separate hanging brackets/fixing lugs need to be fitted to allow independent support of diffuser and plenum box.

### Accessories

Joggled style plenum boxes or pan adapters.

Spigot dampers include; cord operated or quadrant.

12mm thick Class 'O' internal lining.

Turning Vanes.

Fixing lugs or special fixings (by others).

Flush Ends (No Indent).

### Finish

Self finish galvanised or zinc coated steel as standard.

Black paint can be applied to internal faces if required.

## Pressure Drops and Sound Rating

The pressure drop given is for supply grille with damper fully open. When the grille is installed with plenum box, the

pressure loss of the box has to be added to the grille.

	Spigot Velocity m/s					
	1.5	2.0	2.5	3.0	3.5	4.0
<b>Pressure Drop Pa*</b>	2	4	6	8	12	16
<b>Sound Power Level NR*</b>	-	-	25	30	35	40

\* The figures given are approximate - dependent upon spigot entry conditions

## Plenum Box Spigot Volumes (l/s)

	Spigot Velocity m/s					
Diameter (mm)	1.5	2.0	2.5	3.0	3.5	4.0
<b>100</b>	10	15	19	22	26	30
<b>125</b>	18	24	30	35	41	47
<b>150</b>	25	34	42	51	60	68
<b>175</b>	35	46	58	70	82	94
<b>200</b>	45	60	75	91	109	121
<b>225</b>	58	77	96	117	137	151
<b>250</b>	71	95	120	142	170	191
<b>275</b>	86	115	145	172	205	230
<b>300</b>	103	139	172	208	240	275
<b>325</b>	120	160	200	240	280	320
<b>350</b>	140	188	235	280	328	375
<b>400</b>	185	245	310	370	430	495

### Plenum Box Dimensions

#### Type PBL-3

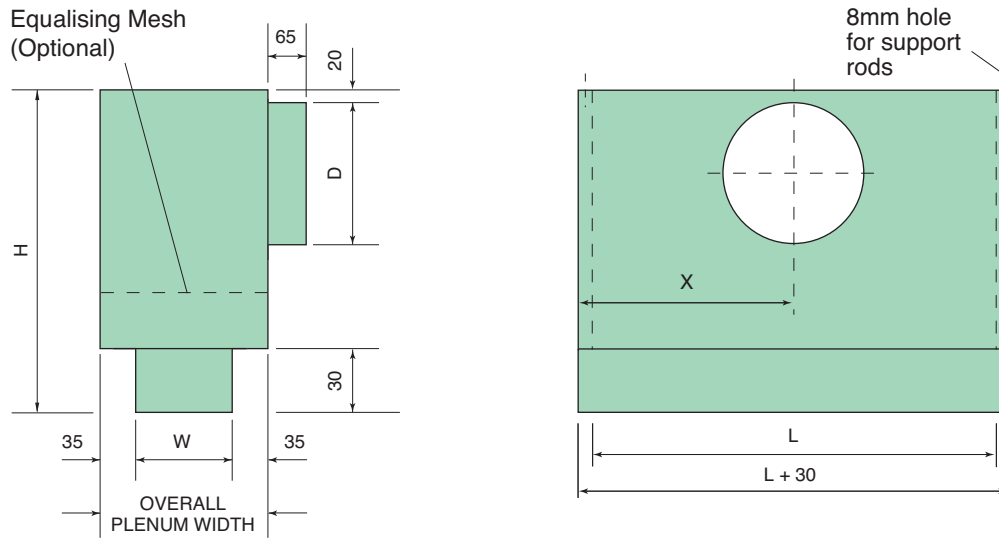

Boxes shown with Indented Ends.  
Profile End Boxes also available.

Angle Bracket fixing available if required.

#### Order Detail

H	L	W	D	C		X
				LH	RH	
-	-	-	-	8mm	8mm	-

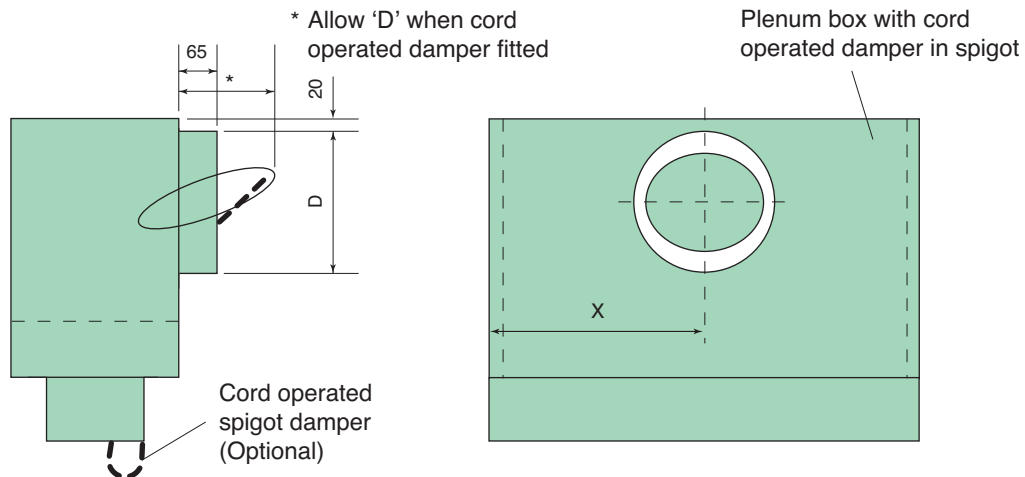

#### Plenum Box Standard Overall Dimensions

Model Type	Slot	Slot 'W' Dimension	Overall Plenum Width	Overall Plenum Height 'H' Dimension	Nominal Spigot Diameter 'D'
LD13 - LD130	1	27	97	230	100
	2	61	131	280	150
	3	95	165	290	160
	4	129	199	330	200
LD14 - LD140	1	38	108	255	125
	2	83	153	290	160
	3	128	198	330	200
	4	172	242	380	250

# Installation and Ordering Information - Plenum Boxes

## Alternative Plenum Installation

Standard installation using drop rods or wires through single 8mm diameter holes on ends of plenum boxes

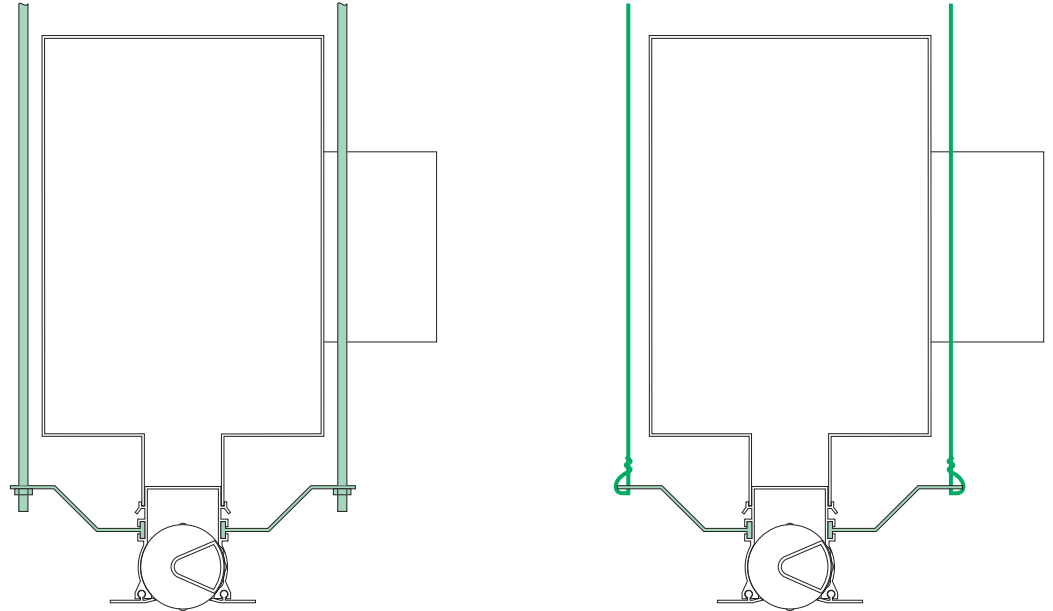

## Ordering Information, Example

Model PBL-3	Internal Lining U	Spigot Damper C	Options 0	Dimensions
<b>Plenum Boxes</b>  <b>PBL-3</b> Linear Plenum Box having a circular side entry spigot	<b>U</b> – Standard Unlined Plenum Box  <b>L</b> – 12mm Class ‘O’ Internal Lining.	<b>N</b> – Plain spigot no damper.  <b>C</b> – Cord operated damper fitted to spigot.  <b>Q</b> – Quadrant damper.	<b>0</b> – No options.  <b>1</b> – Internal faces painted black.  <b>2</b> – Equalising grid.  <b>3</b> – Angle Bracket. Fixing lugs fitted to side of plenum.  <b>4</b> – Profile ends on each end of plenum.	<b>See example below</b>

## Dimensions PBL - 3 Example

Neck Size	Plenum Height	Circular Spigot Diameter	OR	( Sq. / Rect.Spigot Width x Height )	Centre Line of Spigot
<b>L x W</b> 1500 x 150	<b>H</b> 330	<b>∅D</b> 200		<b>C x E</b> 0	<b>G</b> 0

‘0’ Denotes Standard.

**Important Note:** All orders must be addressed to AIR DIFFUSION, Ruskin Air Management Limited.

**Ruskin Air Management Limited  
is a BS EN ISO 9001 registered  
company.**

The statements made in this brochure or by our representatives in consequence of any enquiries arising out of this document are given for information purposes only. They are not intended to have any legal effect and the company is not to be regarded as bound thereby. The company will only accept obligations which are expressly negotiated for and agreed and incorporated into a written agreement made with its customers.

Due to a policy of continuous product development the specification and details contained herein are subject to alteration without prior notice.

**Comprehensive and detailed information  
is available for all Air Diffusion products.  
Visit our website at [www.air-diffusion.co.uk](http://www.air-diffusion.co.uk)**

# Ruskin Air Management Limited



Stourbridge Road, Bridgnorth, Shropshire,  
WV15 5BB England.  
Tel: 01746 761921  
Fax: 01746 760127  
Email: [sales@air-diffusion.co.uk](mailto:sales@air-diffusion.co.uk)  
Website: [www.air-diffusion.co.uk](http://www.air-diffusion.co.uk)

## Air Diffusion

Grilles Diffusers Louvres Chilled Beams